

pco.edge

scientific CMOS camera

low noise

1.4 electrons

high resolution

5.5 megapixel



high dynamic range

22 000:1

high speed

100 fps

The new pco.edge is a breakthrough in scientific imaging cameras, due to its distinctive ability to simultaneously deliver extremely low noise, fast frame rates, wide dynamic range, high quantum efficiency, high resolution and a large field of view - all in one image.

features

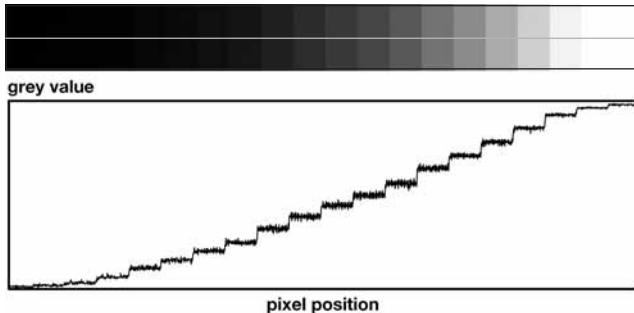

The top image shows an extract of a typical pco.edge recording of a grey scale with a 1 : 10 000 dynamic in 20 steps. The bottom image is a plot of the grey values profile along the centered line through the top image (with gamma 2.2).

supreme image quality

The new pco.edge camera (with scientific CMOS image sensor) features outstanding low read out noise of 1.4 electrons (e^-) rms. Even at maximum speed of 100 frames/s at full resolution of 2560 x 2160 pixel the noise is less than 2 e^- rms. Moreover the pco.edge provides an excellent homogeneous pixel response to light (PRNU, photo response non-uniformity) and an excellent homogeneous dark signal pixel behaviour (DSNU, dark signal non-uniformity), which is achieved by a sophisticated electronic circuit technology and firmware algorithms. The lower figure shows a comparison of a scientific grade CCD and the new pco.sCMOS image sensor under similar weak illumination conditions. This demonstrates the superiority of pco.sCMOS over CCD with regards to read out noise and dynamic, without any smear (the vertical lines in the CCD image).

flexibility

User selectable choice of rolling or global shutter mode for exposure provides flexibility for a wide range of applications. The advantages of rolling shutter are high frame rates and low read out noise whereas global shutter provides snapshot images for fast moving objects.

free of drift

The new pco.edge camera features + 5 °C stabilized Peltier cooling, allowing for a continuous operation free of any drift phenomena in image sequences.

22 000:1 dynamic range

Due to the excellent low noise and the high fullwell capacity of the sCMOS image sensor an intra scene dynamic range of better than 22 000 : 1 is achieved. A unique architecture of dual column level amplifiers and dual 11 bit ADCs is designed to maximize dynamic range and to minimize read out noise simultaneously. Both ADC values are analyzed and merged into one high dynamic 16 bit value.

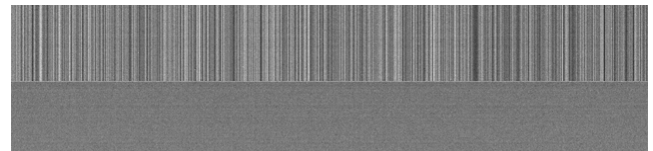

The upper image shows the typical fixed pattern noise structures in the dark image of a standard CMOS image sensor, while the lower image shows a corresponding typical sCMOS dark image (same scale).

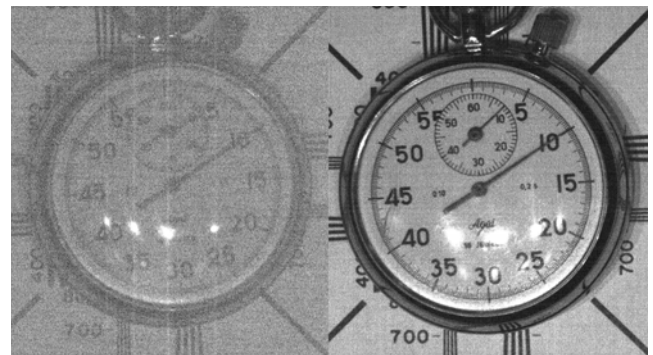

The left image was recorded by a scientific CCD camera while the right image was recorded by a pco.edge under identical conditions.

features

reaching emCCD domain

In the past emCCD image sensors featuring on-chip amplification were developed to detect the lowest level of light. However, amplification, while reducing read out noise, comes at the expense of dynamic range. Both features are not possible simultaneously in emCCD sensors. In addition, the amplification process generates excess noise, which reduces the effective quantum efficiency (QE_{eff}) of the emCCD sensor by the factor of two (e.g. the 90 % QE of a back illuminated emCCD sensor has an QE_{eff} of 45 %). The excess noise present in emCCDs makes the pco.sCMOS the sensor of choice at light conditions above 2 photons per pixel (@ 60 % QE, assuming a cooled sensor with dark current = 0). Furthermore, available emCCD sensors are limited in resolution and frame rate.

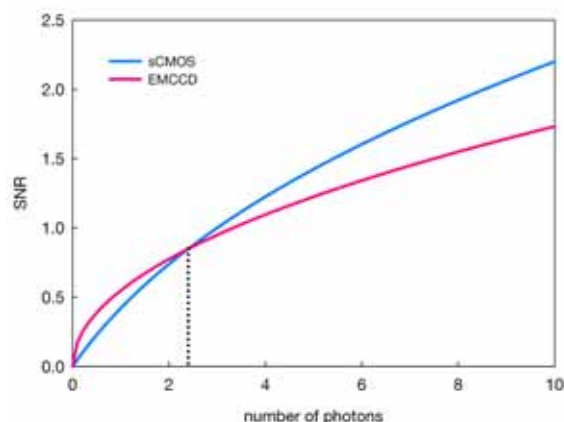

The graph shows the signal-to-noise (SNR) curves of a typical emCCD camera (gain = 1000) and a sCMOS camera vs. number of photons.

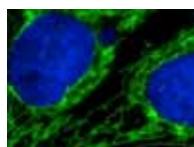
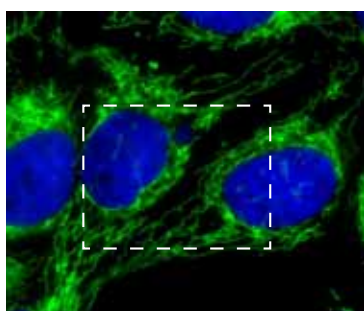

The two images show in comparison the field of view of a 5.5 Mpixel resolution vs. a 1.3 Mpixel resolution, courtesy of Dr. Stefan Jakobs, Dept. of NanoBiophotonics, MPI for Biophysical Chemistry

high resolution

A 5.5 Mpixel resolution in combination with a moderate chip size (21.8 mm diagonal, 6.5 μm pixel pitch) benefits microscopy applications with low magnification factor and large field of view, thereby reducing processing times and increasing throughput. The figure compares the potential of the new field of view of the pco.edge to the 1.3 Mpixel image resolution which is widely used in microscopy applications for scientific cameras.

high speed

The new pco.edge offers in fast mode a frame rate of 100 frames/s (fps) at full resolution of 2560 x 2160 pixel. As in many CMOS based cameras the frame rate increases significantly if smaller regions of interest (ROI) are used. The reduction of the image area works as well in favour of the frame rate of CCD sensors, but here unwanted regions still need to be read out at the expense of the total readout speed. The typical frame rate for a 1.3 Mpixel scientific CCD camera (6 e^- read out noise) is 10 fps. The new pco.edge camera provides at 1.3 Mpixel resolution (< 2 e^- read out noise) a frame rate of 210 fps in comparison.



Resolution 640 x 480 pixel @ 460 frames/s (color version)

technical data

image sensor

type of sensor	scientific CMOS (sCMOS)
image sensor	CIS2051
resolution (h x v)	2560 x 2160 pixel
pixel size (h x v)	6.5 μm x 6.5 μm
sensor format / diagonal	16.6 mm x 14.0 mm / 21.8 mm
shutter modes	rolling and global (snapshot)
MTF	76.9 lp/mm (theoretical)
fullwell capacity	30 000 e ⁻
readout noise	< 1.4 e ⁻ rms @ 33 fps (rs ¹ , ssc ²) < 2.0 e ⁻ rms @ 100 fps (rs ¹ , fsc ²) < 3 e ⁻ rms @ 50 fps (gs ¹ , fsc ²)
dynamic range	22 000 : 1 (86.9 dB)
quantum efficiency	57 % @ peak
spectral range	370 nm .. 1100 nm
dark current	2 e ⁻ /pixel/s (rs ¹) @ 5 °C 240 e ⁻ /pixel/s (gs ¹) @ 5 °C
DSNU	< 2 e ⁻ rms
anti blooming factor	1 : 10 000

camera

frame rate	100 fps @ 2560 x 2160 pixel (rs ¹ , fsc ²) 50 fps @ 2560 x 2160 pixel (gs ¹ , fsc ²)
exposure/shutter time	500 μs .. 2 s (rs ¹) 10 μs .. 100 ms (gs ¹)
dynamic range A/D	16 bit (merged from 2 x 11 bit) ³
A/D conversion factor	0.46 e ⁻ /count
pixel scan rate	95.3 MHz (ssc ²) / 286 MHz (fsc ²)
pixel data rate	190.7 Mpixel/s / 572 Mpixel/s
region of interest	selectable
non linearity	< 1 %
cooled image sensor temperature	+ 5 °C (@ + 25 °C ambient)
cooling method	Peltier with forced air (fan)
trigger input signals	frame trigger, sequence trigger
trigger output signals	exposure, busy
data interface	dual Camera Link (full, 10 taps)
time stamp	in image (1 μs resolution)

¹ rs = rolling shutter / gs = global shutter

² ssc = slow scan mode / fsc = fast scan mode. The fast scan mode is always visually lossless compressed to 12 bit due to speed limitations given by the Camera Link interface.

³ The high dynamic signal is simultaneously converted at high and low gain by two 11 bit A/D converters and the two 11 bit values are sophisticatedly merged into one 16 bit value.

general

power supply	12 .. 24 VDC (+/- 10 %)
power consumption	20 W
weight	700 g
ambient temperature	+ 10 °C .. + 40 °C
operating humidity range	10 % .. 80 % (non-condensing)
storage temperature range	- 10 °C .. + 60 °C
optical interface	F-mount (std.) / C-mount (opt.)
CE / FCC certified	yes

frame rate table

	fast scan ²		slow scan ²	
typical examples	rolling sh.	global sh.	rolling sh.	global sh.
2560 x 2160	100 fps	50 fps	33.3 fps	16.7 fps
1920 x 1080	200 fps	100 fps	66.7 fps	33.3 fps
1600 x 1200	180 fps	90 fps	60 fps	30 fps
1280 x 1024	210 fps	105 fps	70 fps	35 fps
640 x 480	450 fps	225 fps	150 fps	75 fps
320 x 240	900 fps	450 fps	300 fps	150 fps

quantum efficiency

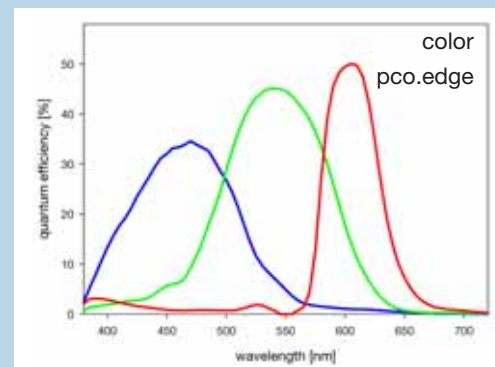
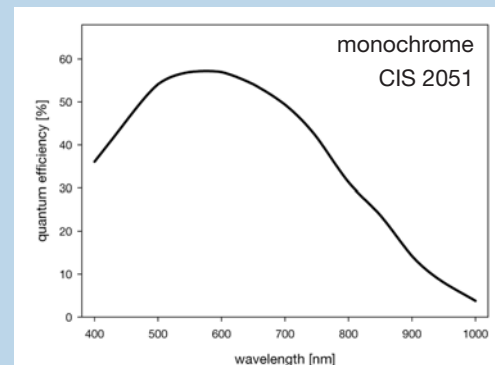

technical data

software

Camware is provided for camera control, image acquisition and archiving of images in various file formats (WindowsXP and later). A free software development kit (SDK), including a 32bit dynamic link library, for user customization, integration on PC platforms is available. Drivers for popular third party software packages are also available.

(Please visit www.pco.de for more information)

options

monochrome & color versions available; custom made versions (e.g. water cooling, fan-less, deep cooled...)

dimensions

F-mount and c-mount lens changeable adapter.

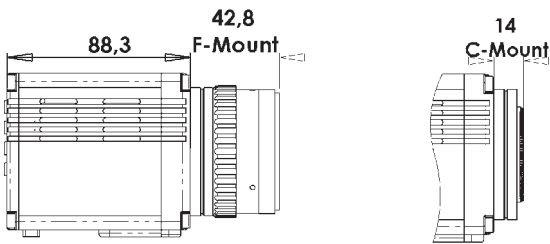

All dimensions are given in millimeter.

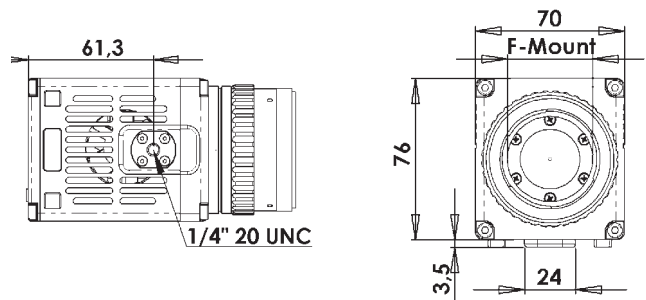

camera views



Further information can be found on www.pco.de & www.pco-scmos.com



applications

life science

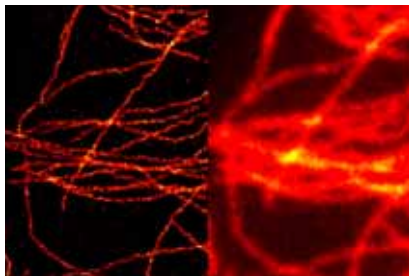

A widefield (right) and a GSDIM super-resolution (left) microscopy image of tubulin fibers, courtesy of Leica Microsystems, Germany

physical science

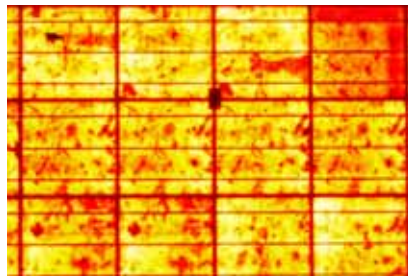

Electroluminescence of a solar cell panel to measure and visualize defects of the cells, recorded with the pco.edge camera, PCO, Germany

industry



Bottle inspection measuring at a high dynamic range, courtesy of Kronen AG, Regensburg, Germany

life science

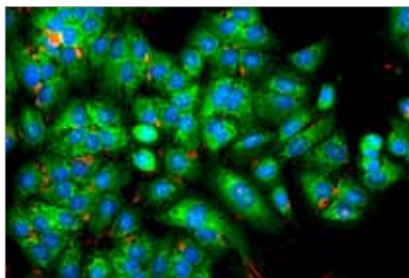

Human liver cancer cells, which have been stained with different probes for membranes, nuclei and permeability, courtesy of TILL Photonics, Germany

life science

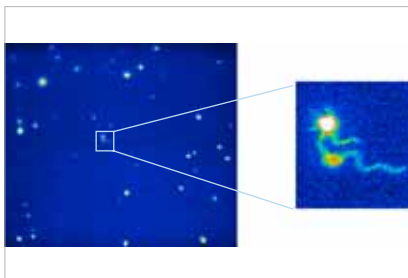

A widefield microscopy image of small bacteria obtained with the pco.edge camera, where the enlarged area shows the stained flagella, courtesy of Prof. Dr. Wirth, Microbiology, University of Regensburg, Germany

TV / Broadcasting



A high speed image of a horse race finish in full HD. The 200 fps at full HD together with the supreme image quality are useful features of the pco.edge for slow motion applications.

application areas

■ Live cell microscopy ■ Particle Imaging Velocimetry (PIV) ■ Single molecule detection ■ Super resolution microscopy ■ TIRF microscopy / waveguides ■ Spinning disk confocal microscopy ■ Genome sequencing (2nd and 3rd gen) ■ FRET ■ FRAP ■ Lucky astronomy / imaging ■ Adaptive optics ■ Solar astronomy ■ Fluorescence spectroscopy ■ Bio- & Chemi - luminescence ■ High content screening ■ Photovoltaic inspection ■ X-ray tomography ■ Ophthalmology ■ Flow cytometry ■ Biochip reading ■ Machine vision ■ TV / Broadcasting ■ Spectral (hyperspectral) imaging ■ Laser Induced Breakdown Spectroscopy (LIBS)

europa

PCO AG
Donaupark 11
93309 Kelheim, Germany

fon +49 (0)9441 2005 50
fax +49 (0)9441 2005 20
info@pco.de
www.pco.de

america

The Cooke Corporation
6930 Metroplex Drive
Romulus, Michigan 48174, USA

tel (248) 276 8820
fax (248) 276 8825
info@cookecorp.com
www.cookecorp.com